

# **VOLMED**

Serving Healthcare Since 1971



## **GENERAL SURGICAL INSTRUMENTS CATALOG**

[www.volmed.co.uk](http://www.volmed.co.uk)

## About Us

With over 50 years of industry experience, VOLMED is a family-owned company specializing in the supply of high-quality surgical instruments to the medical and surgical markets across the United Kingdom, Europe, and globally. Our extensive expertise enables us to assist with project research and development, ensuring that we meet the evolving needs of our clients.

Our philosophy is simple: we treat our customers as we would like to be treated, which places customer satisfaction at the forefront of our priorities. This approach naturally aligns with our commitment to delivering products of the highest quality. Ultimately, our goal is to empower you to provide the best possible care and achieve improved health outcomes by streamlining the process of stocking your practice.

We take pride in the breadth of our product offerings, understanding that sourcing medical tools and surgical instruments from multiple suppliers can be both time-consuming and challenging. To address this, we strive to be your one-stop shop for all your requirements.

## Our History

Our story began over 50 years ago within a family deeply rooted in the medical instrument manufacturing industry. The foundation of our thriving business was built by a team of highly ambitious professionals with expertise in producing plastic surgery, dental and surgical instruments.

Inspired by the potential for excellence, our founder established VOLMED, a company dedicated to providing outstanding customer service and high-quality products. Since then, our team of dedicated professionals has worked tirelessly to ensure that customers worldwide receive only the finest surgical instruments and related services. We never compromise on quality, continually investing in our team, resources, equipment, and processes. Every detail is meticulously examined to ensure we can adapt to changing demands while maintaining the highest standards of quality.

## Our Promise

At VOLMED, our commitment to excellence is unwavering. We strive to achieve the highest standards in everything we do, working relentlessly to provide exceptional service to our customers and everyone associated with our company. We view it as our responsibility to contribute to a better future for the entire community, and we are dedicated to making this vision a reality.



## **Quality**

Our commitment to quality is reflected in our CE and UKCA-marked instruments, manufactured in accordance with stringent global quality assurance standards, including ISO 9001:2015, ISO 13485:2016, and the Medical Device Directive 93/42/EEC.

## **Our Mission**

We are committed to manufacturing and supplying products that meet the highest standards of strength, accuracy, and reliability. Recognizing the critical role our equipment plays in saving lives and improving health, we take this responsibility seriously. Our mission is to simplify the procurement process by offering a comprehensive range of high-quality surgical products under one roof.

## **Products**

At VOLMED, surgical instruments are at the core of our offerings. We provide a wide range of high-quality surgical products suitable for use in operating rooms, wards, veterinary practices, dentistry, and chiropody. Our instruments are crafted to strict standards using a blend of modern technology and traditional craftsmanship, in full compliance with the Medical Devices Directive 93/42/EEC. Complete traceability is maintained throughout the manufacturing process.

To ensure exceptional product performance and reliability, all our products undergo rigorous engineering analysis and stringent inspection methods. VOLMED instruments are guaranteed for five years against manufacturing defects and are made from premium surgical-grade stainless steel, in accordance with ISO 7153-1:2016 specifications. Explore our product listings and catalogues to discover our comprehensive range of surgical instruments.

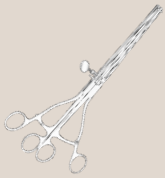

# Intestinal & Stomach



Serving Healthcare Since 1971

# Intestinal & Stomach

Serving Healthcare Since 1971

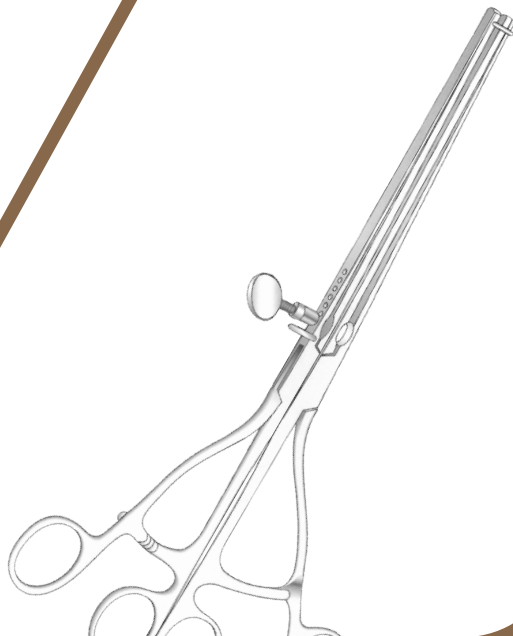

# 35

# 35

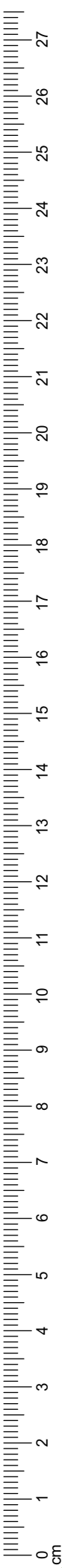



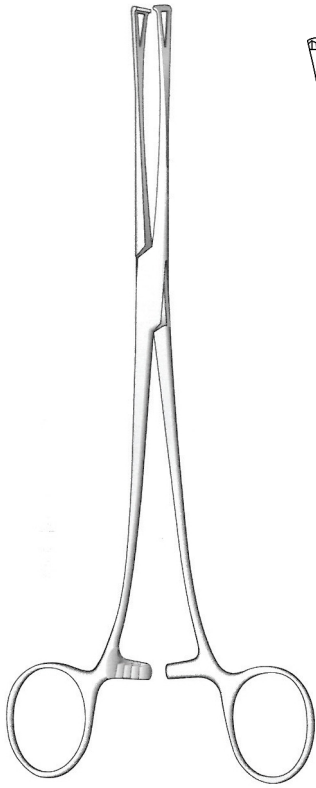

**Lockwood**  
V-035-085  
20 cm / 8"

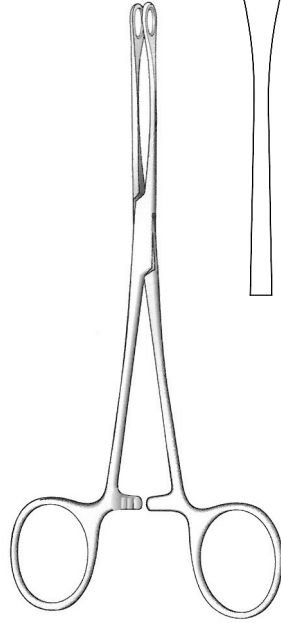

**Williams**  
V-035-086  
16 cm / 6 1/4"

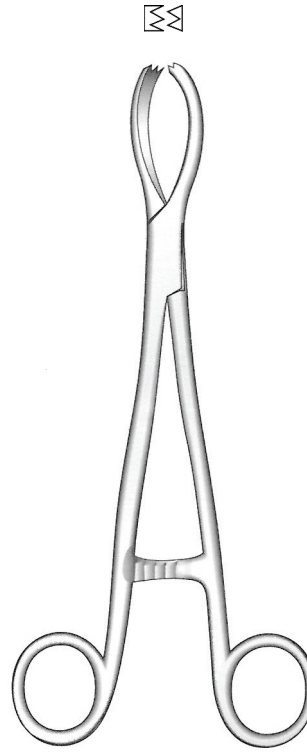
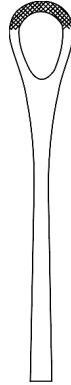

**Littlewood**  
V-035-190  
19 cm / 7 1/2"

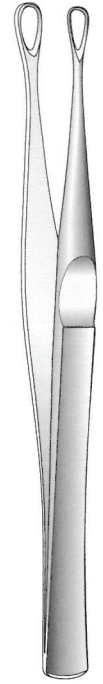

**Denis-Browne**  
V-035-300  
18 cm / 7"

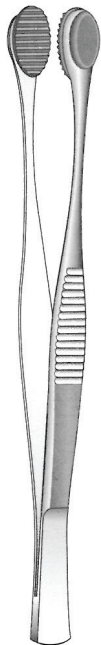

**Young**  
V-035-290  
21 cm / 8 1/4"

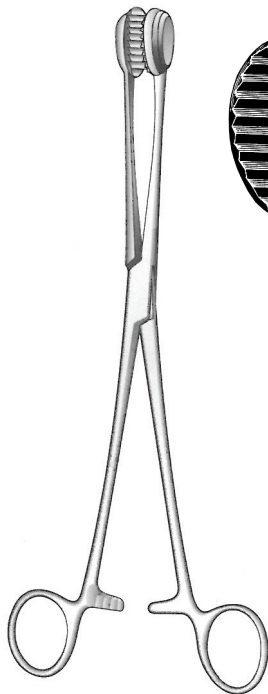

**Child**  
V-035-280  
24 cm / 9 1/2"

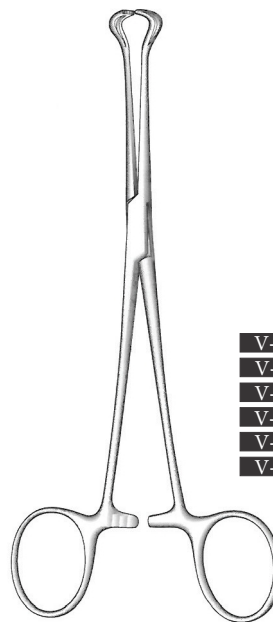

**Babcock**  
Straight

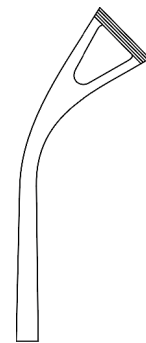
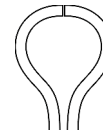

V-035-810	14 cm / 5 1/2"	V-035-800
V-035-281	16 cm / 6 1/4"	V-035-801
V-035-282	18 cm / 7"	V-035-802
V-035-284	20 cm / 8"	V-035-803
V-035-285	24 cm / 9 1/2"	V-035-804
V-035-286	30 cm / 12"	V-035-805
Straight		Angled 45°

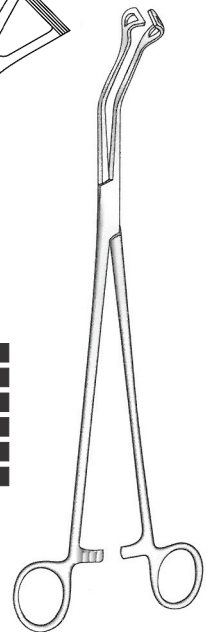

**Babcock**  
Angled 45°

# Intestinal & Stomach

Tissue and Organ Holding Forceps

Gewebe- und Organ-Faßzangen

Pinzas para tejidos Y organos

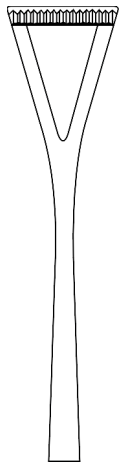

13 mm jaws

**V-035-287**

18 cm / 7"

**V-035-289**

20 cm / 8"

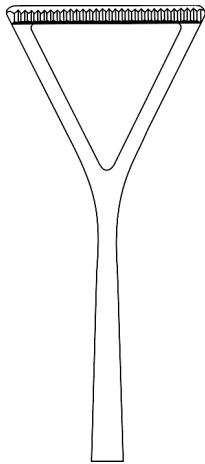

25 mm jaws

**V-035-288**

20 cm / 8"

**V-035-291**

23 cm / 9"

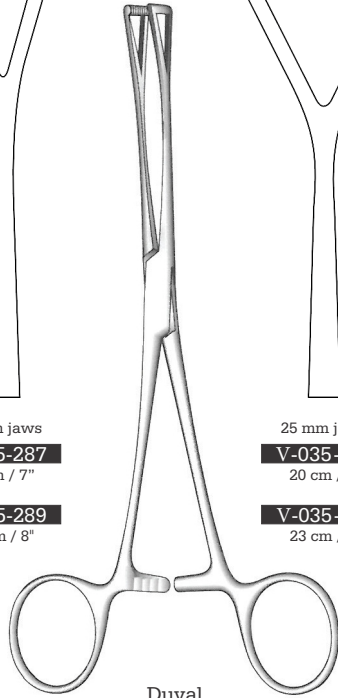

Duval

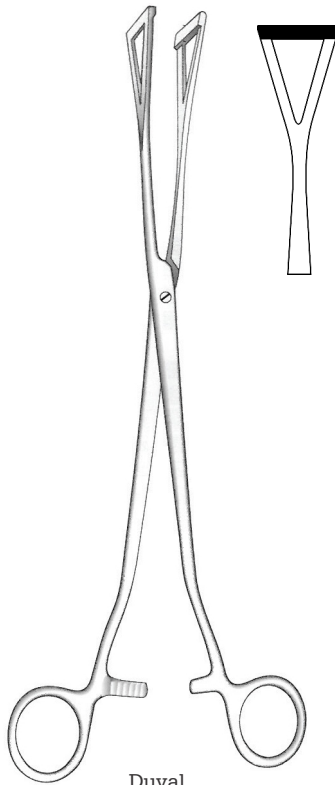

Duval

**V-035-1000**

28 cm / 11"

25 mm wide jaws

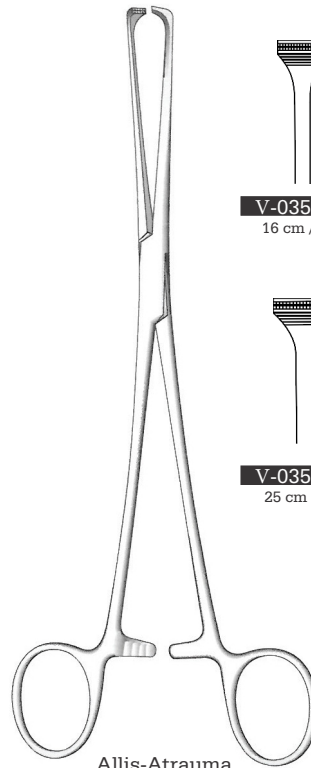

Allis-Atrauma



**V-035-294**

16 cm / 6 1/4"



**V-035-295**

20 cm / 8"



**V-035-296**

25 cm / 10"

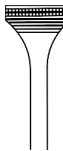

**V-035-297**

30 cm / 12"

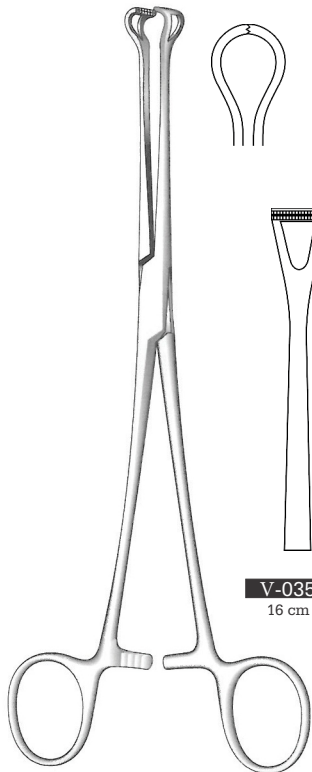

Babcock-Atrauma



**V-035-292**

16 cm / 6 1/4"

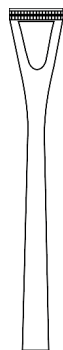

**V-035-293**

20 cm / 8"

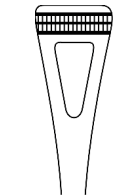
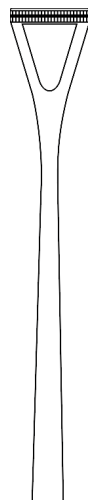

**V-035-298**

18 cm / 7"

Narrow

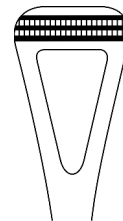

**V-035-299**

20 cm / 8"

Medium

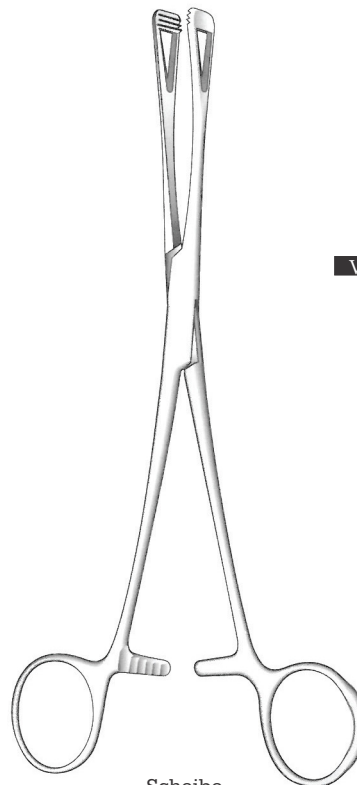

Scheibe

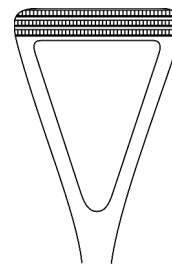

**V-035-1010**

23 cm / 9"

Wide



V-035-720 15 cm / 6"  
 V-035-721 18 cm / 7"  
 V-035-722 20 cm / 8"  
 V-035-723 23 cm / 9"  
 V-035-724 25 cm / 10"  
 V-035-725 30 cm / 12"  
 3:4 Teeth

**Allis-Baby**

V-035-301  
 13 cm / 5"

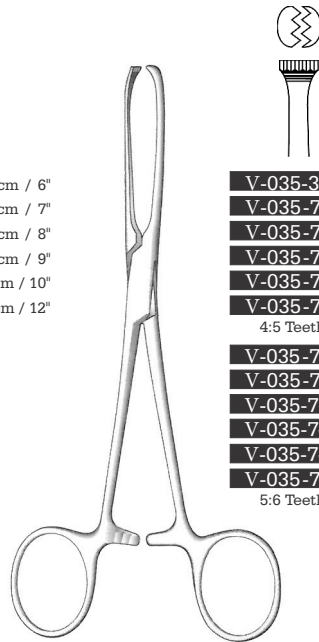

V-035-302 15 cm / 6"  
 V-035-730 18 cm / 7"  
 V-035-731 20 cm / 8"  
 V-035-732 23 cm / 9"  
 V-035-733 25 cm / 10"  
 V-035-734 30 cm / 12"  
 4:5 Teeth  
 V-035-740 15 cm / 6"  
 V-035-741 18 cm / 7"  
 V-035-742 19 cm / 7½"  
 V-035-743 23 cm / 9"  
 V-035-744 25 cm / 10"  
 V-035-745 30 cm / 12"  
 5:6 Teeth

**Allis**

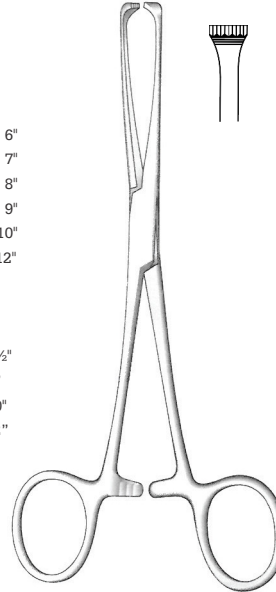

**Boys-Allis**

V-035-306  
 15 cm / 6"  
 7:8 Teeth

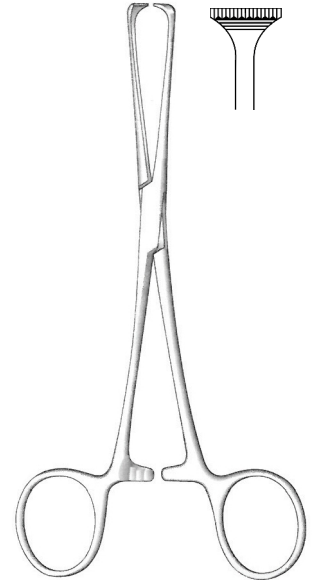

**Allis-Adair**

V-035-307  
 15 cm / 6"  
 10:11 Teeth

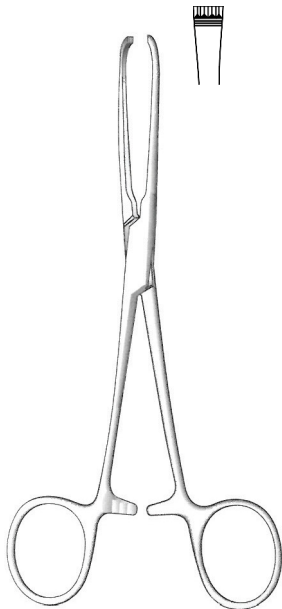

**Judd-Allis**

V-035-308 15 cm / 6"  
 V-035-309 19 cm / 7½"

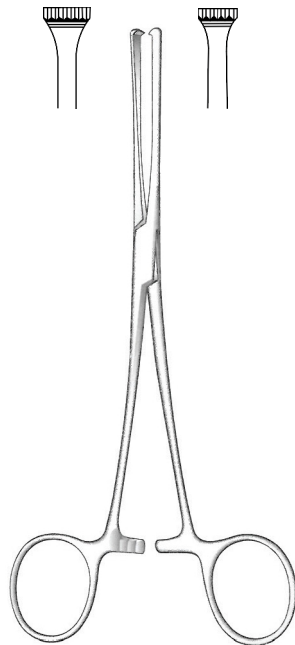

**Lockwood-Allis**

V-035-070 16 cm / 6¼"  
 V-035-080 20 cm / 8"

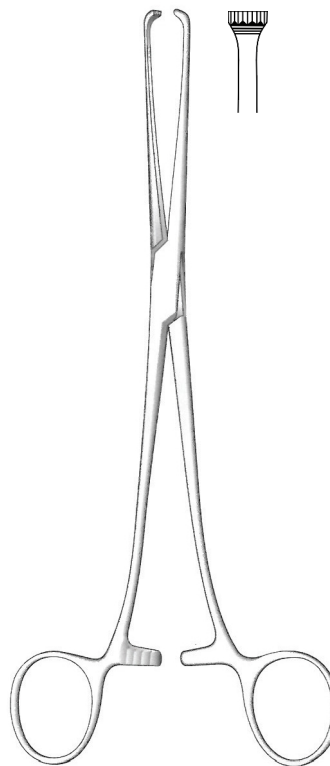

**Allis**

V-035-081  
 20 cm / 8"  
 5:6 Teeth

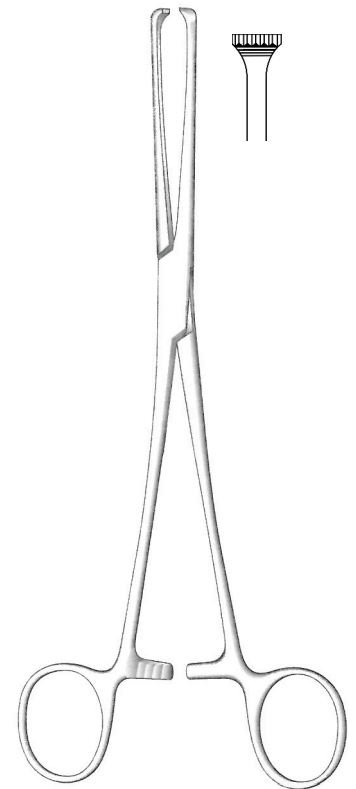

**Thoms-Allis**

V-035-082  
 20 cm / 8"  
 6:7 Teeth



# Intestinal & Stomach

Tissue and Organ Holding Forceps, Intestinal Clamp Forceps  
 Gewebe- und Organ-FaBzangen, Dramkelmmen  
 Pinzas para tejidos Y organos, Pinzas-clamps intestinales

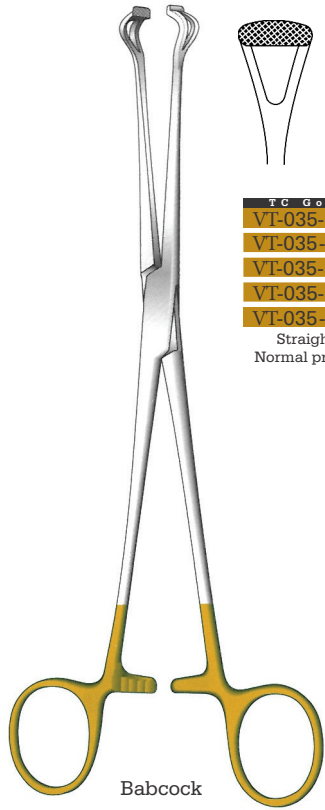

- TC Gold**
- VT-035-351** 16 cm / 6¼"
  - VT-035-380** 18 cm / 7"
  - VT-035-352** 20 cm / 8"
  - VT-035-381** 24 cm / 9½"
  - VT-035-382** 30 cm / 12"
- Straight  
Normal profile

Babcock

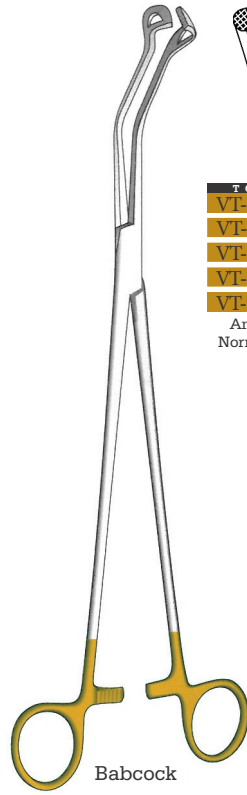

- TC Gold**
- VT-035-370** 16 cm / 6¼"
  - VT-035-372** 18 cm / 7"
  - VT-035-371** 20 cm / 8"
  - VT-035-373** 24 cm / 9½"
  - VT-035-374** 30 cm / 12"
- Angled 45°  
Normal profile

Babcock

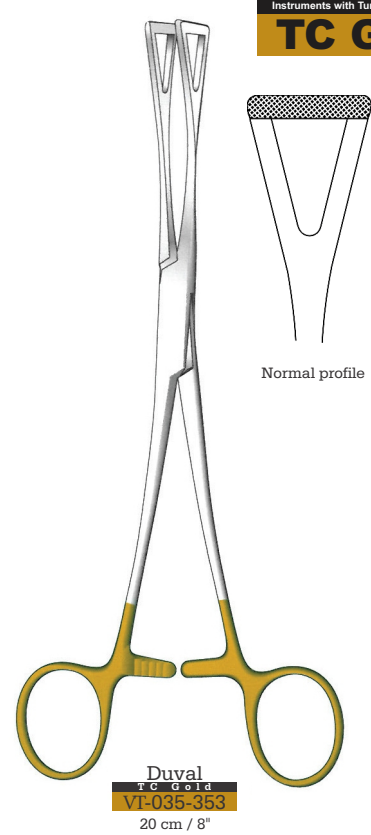

Instruments with Tungsten Carbide Inserts  
**TC GOLD**

Normal profile

Duval  
**TC Gold**  
**VT-035-353**  
 20 cm / 8"

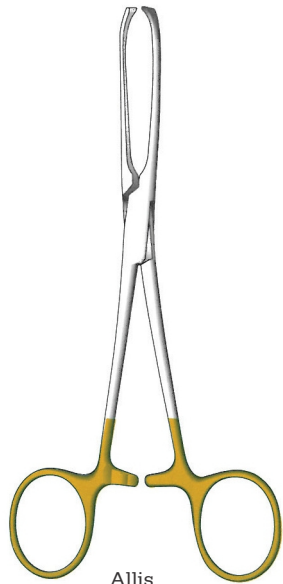

- Allis**
- TC Gold**
- VT-035-400** 15 cm / 6"
  - VT-035-401** 19 cm / 7½"
  - VT-035-402** 23 cm / 9"
  - VT-035-403** 25 cm / 10"
  - VT-035-404** 30 cm / 12"

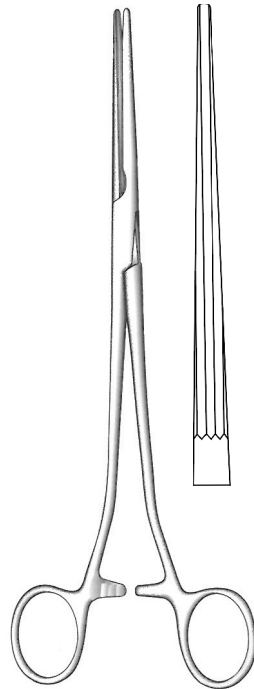

**Dannes**  
**V-035-368**  
 23 cm / 9"

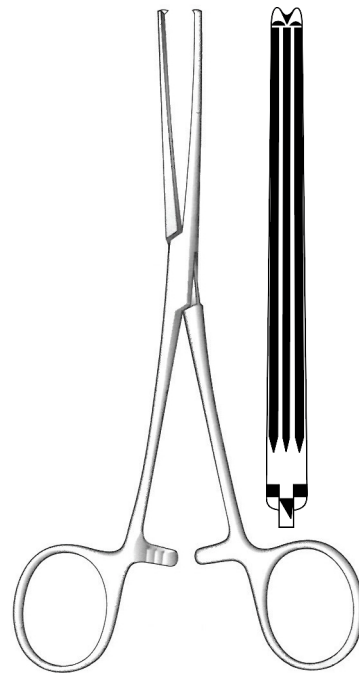

**Allen**

- V-035-1020** 20.5 cm / 8¼"
- V-035-1025** 24 cm / 9½"

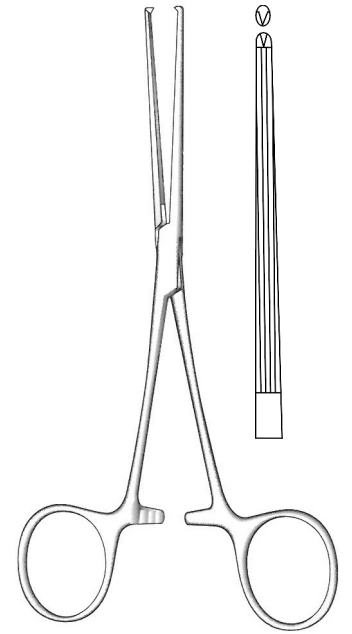

**Baby-Allen**  
**V-035-371**  
 16.5 cm / 6½"

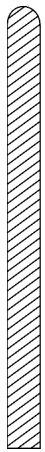

V-035-355

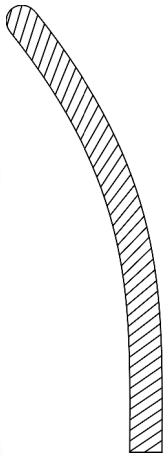

V-035-356

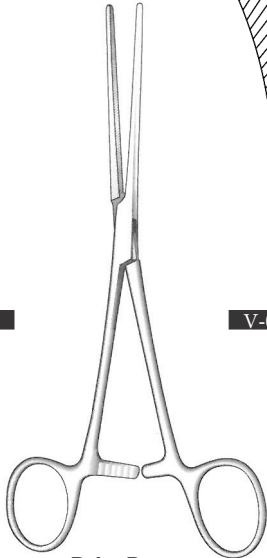

Baby-Doyen  
17 cm / 6 3/4"

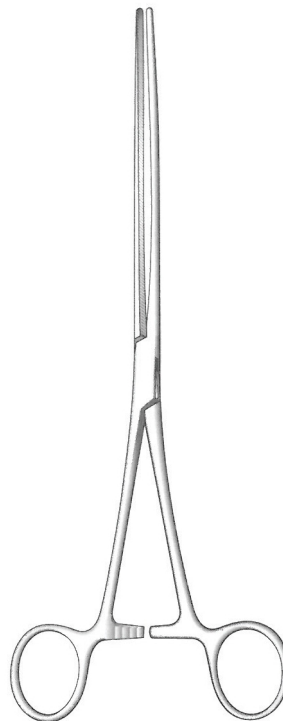

Doyen

V-035-357 21 cm / 8 1/4"  
V-035-358 23 cm / 9"



V-035-359  
V-035-361

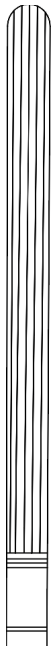

V-035-362 17 cm / 6 3/4"  
V-035-363 21 cm / 8 1/4"  
V-035-364 24 cm / 9 1/2"

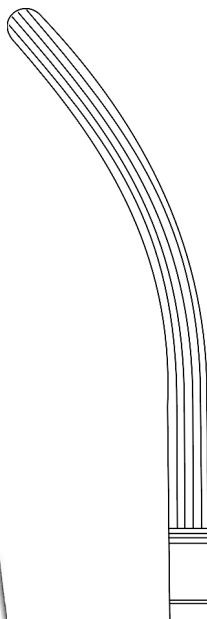

V-035-1030 17 cm / 6 3/4"  
V-035-1032 21 cm / 8 1/4"  
V-035-1034 24 cm / 9 1/2"

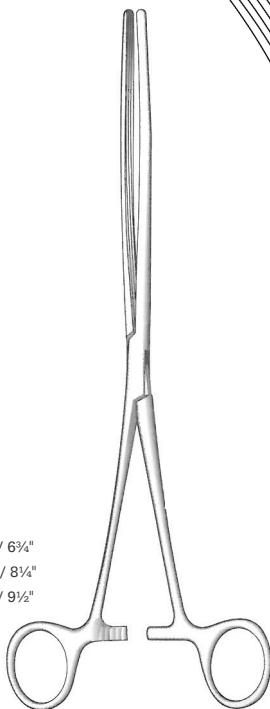

Mayo-Robson / Doyen

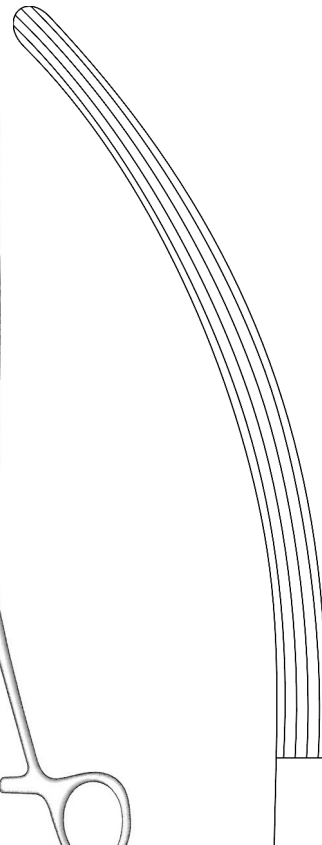

Mayo Robson  
25 cm / 10"



V-035-367 V-035-366

# Intestinal & Stomach

Atrauma Intestinal and Stomach Clamp Forceps with Serrations

Atrauma Darm-und Magnklemmen mit Zahnung

Atrauma Pinzas-Clamps intestinales con dentado

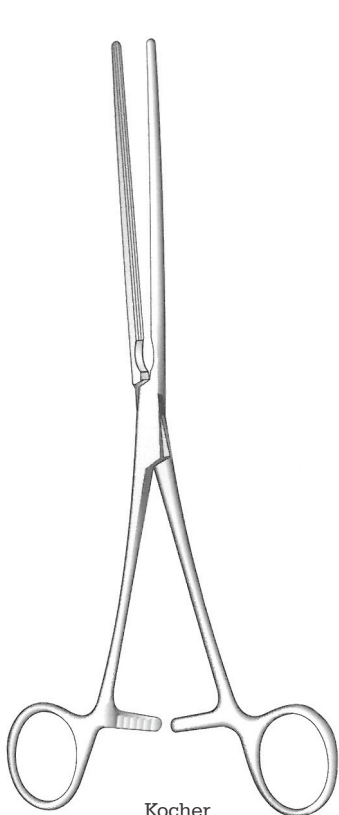

**Kocher**  
Very elastic

- V-035-372 22 cm / 8 3/4"
- V-035-374 25 cm / 10"
- V-035-376 28 cm / 11"

- V-035-373
- V-035-375
- V-035-377

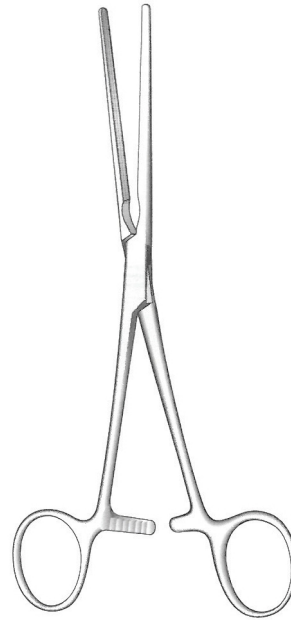
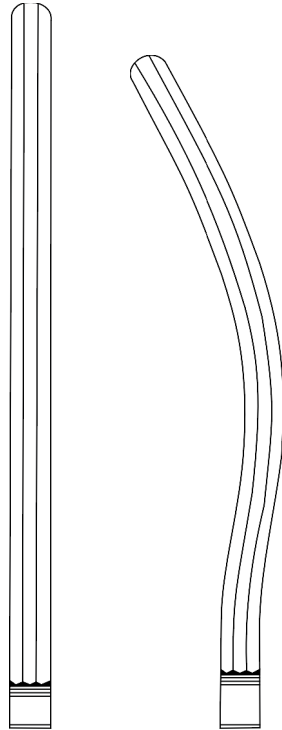

**Doyen-Atrauma**

- |           |                |           |
|-----------|----------------|-----------|
| V-035-378 | 13 cm / 5"     | V-035-384 |
| V-035-379 | 16 cm / 6 1/4" | V-035-385 |
| V-035-381 | 18 cm / 7"     | V-035-386 |
| V-035-382 | 21 cm / 8 1/4" | V-035-387 |
| V-035-383 | 23 cm / 9"     | V-035-388 |

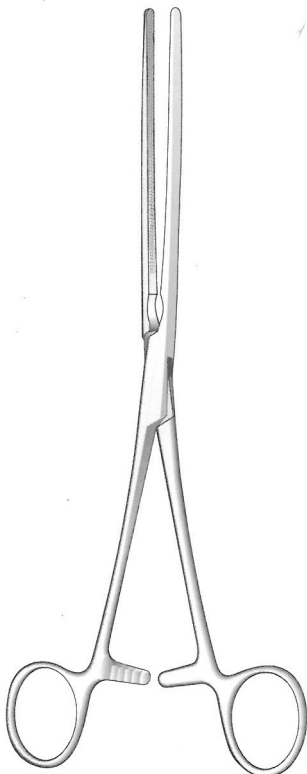
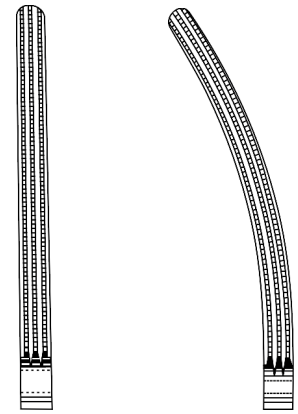

**Kocher-Atrauma**

- V-035-389 22 cm / 8 3/4"
- V-035-391 25 cm / 10"
- V-035-392 28 cm / 11"
- V-035-393
- V-035-394
- V-035-395

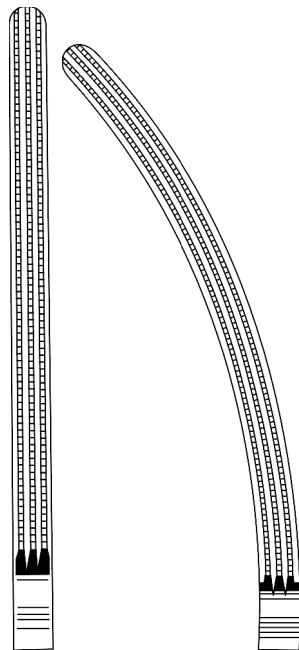

**V-035-396**

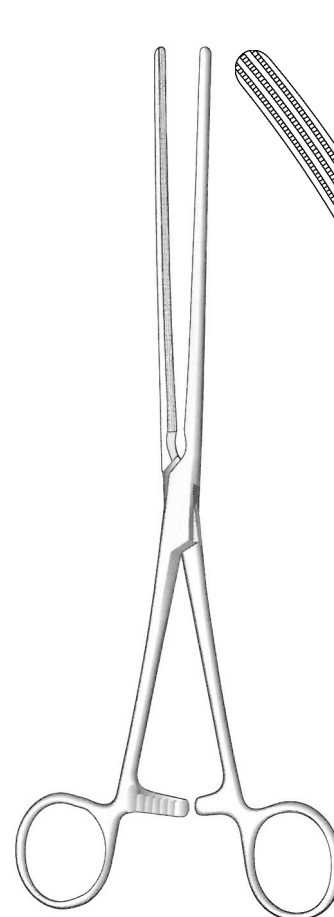

**Mayo-Robson-Atrauma**  
25 cm / 10"

**V-035-397**

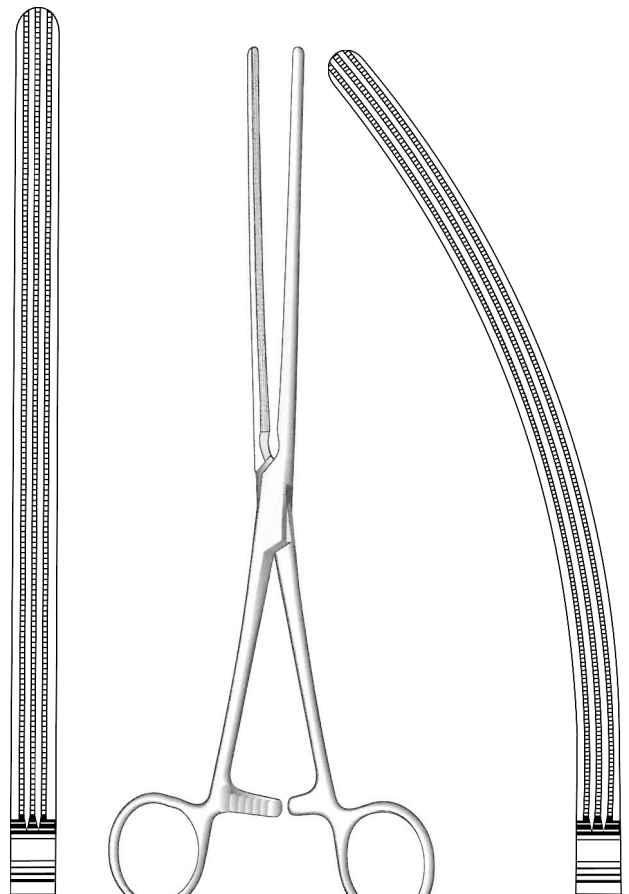





**Veidenheimer**  
**V-035-398**  
23 cm / 9"

**Fehland**  
**V-035-399**  
24 cm / 9 1/4"

**Resano**  
**V-035-402**  
30 cm / 12"

# Intestinal & Stomach

Atrauma Intestinal Clamps, Sigmoid Anastomosis Forceps

Atrauma Darmklemmen, Rektum-Anastomosenklemmen

Atrauma Pinzas intestinales, Pinzas para anastomosis rectales

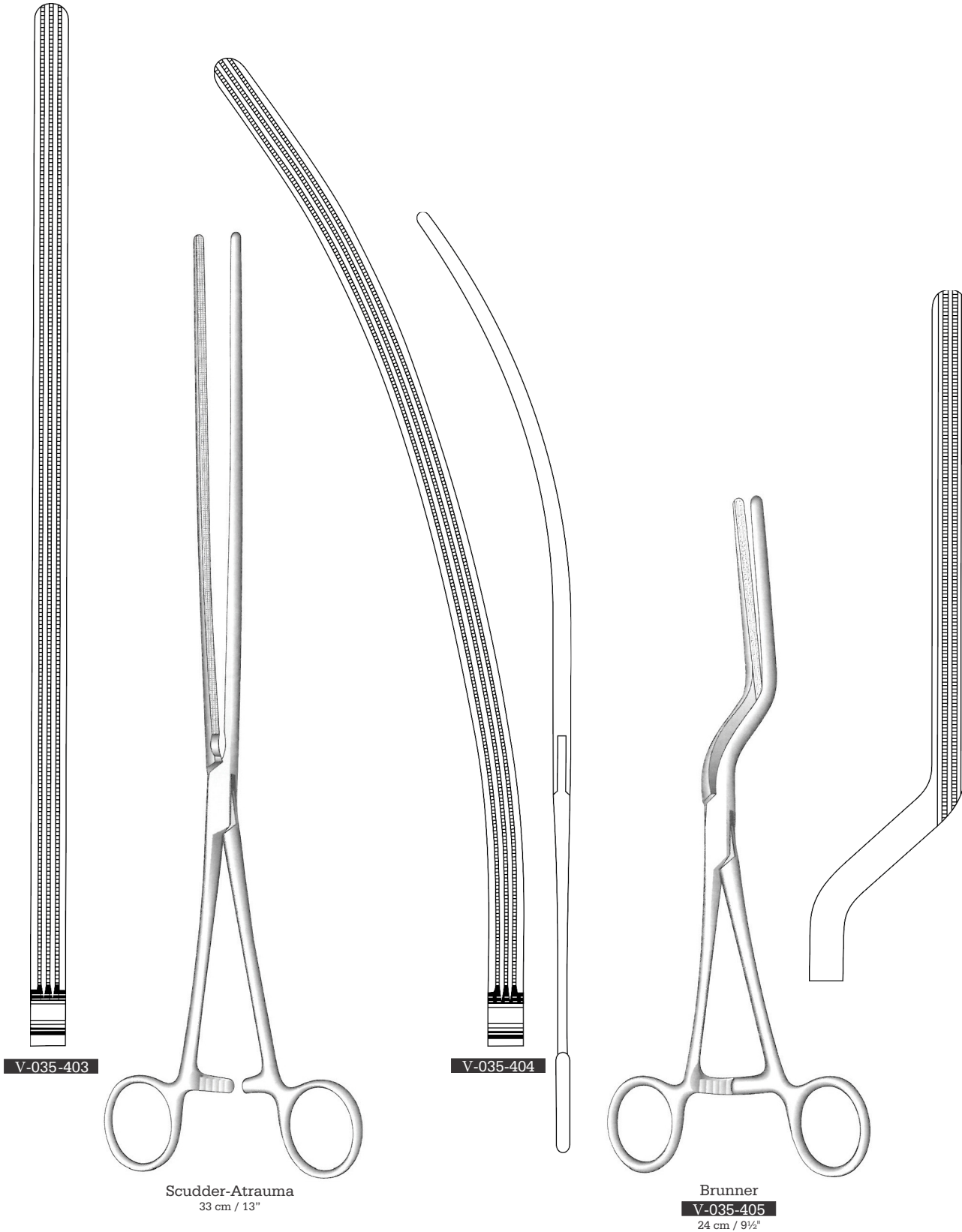

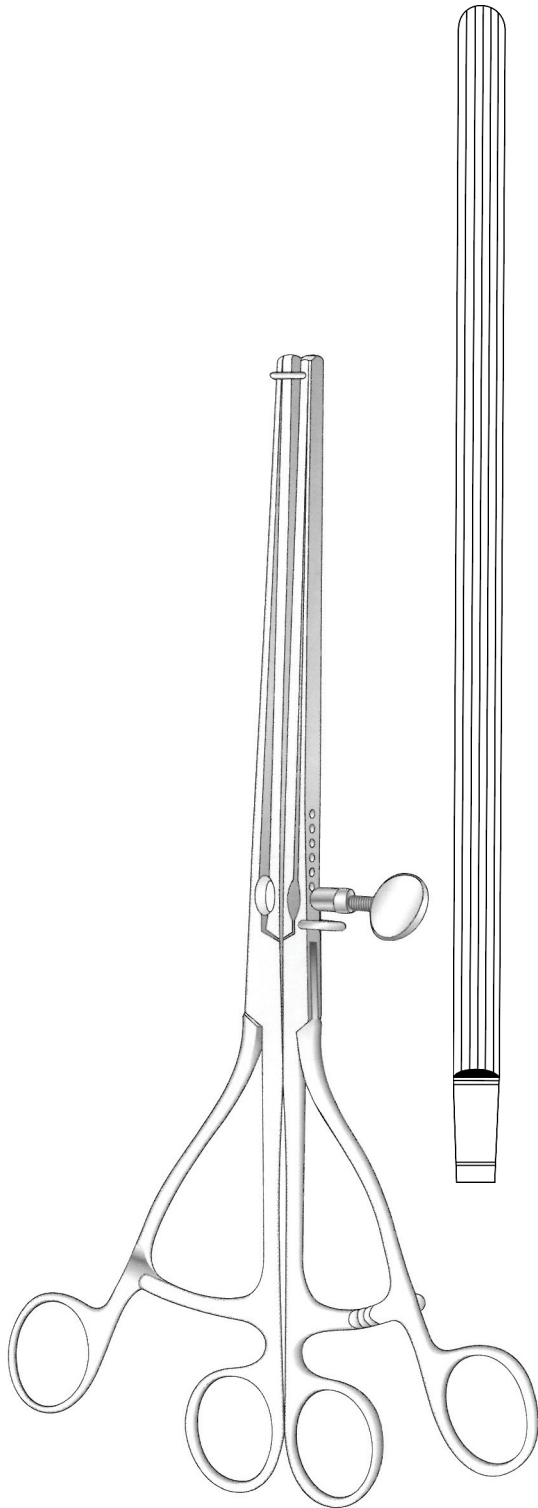

Lane  
V-035-630  
30 cm / 12"

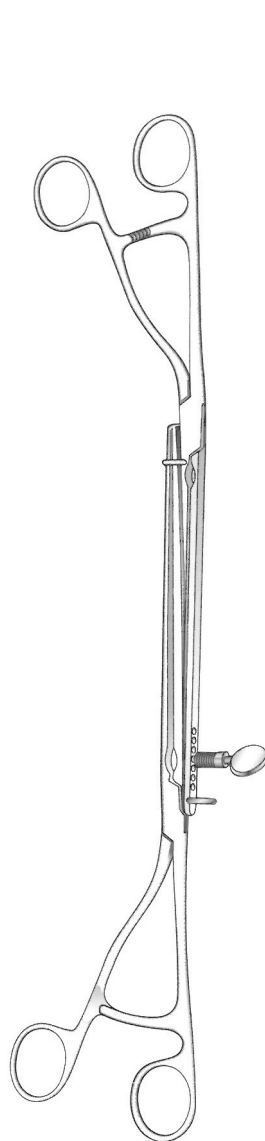

V-035-631

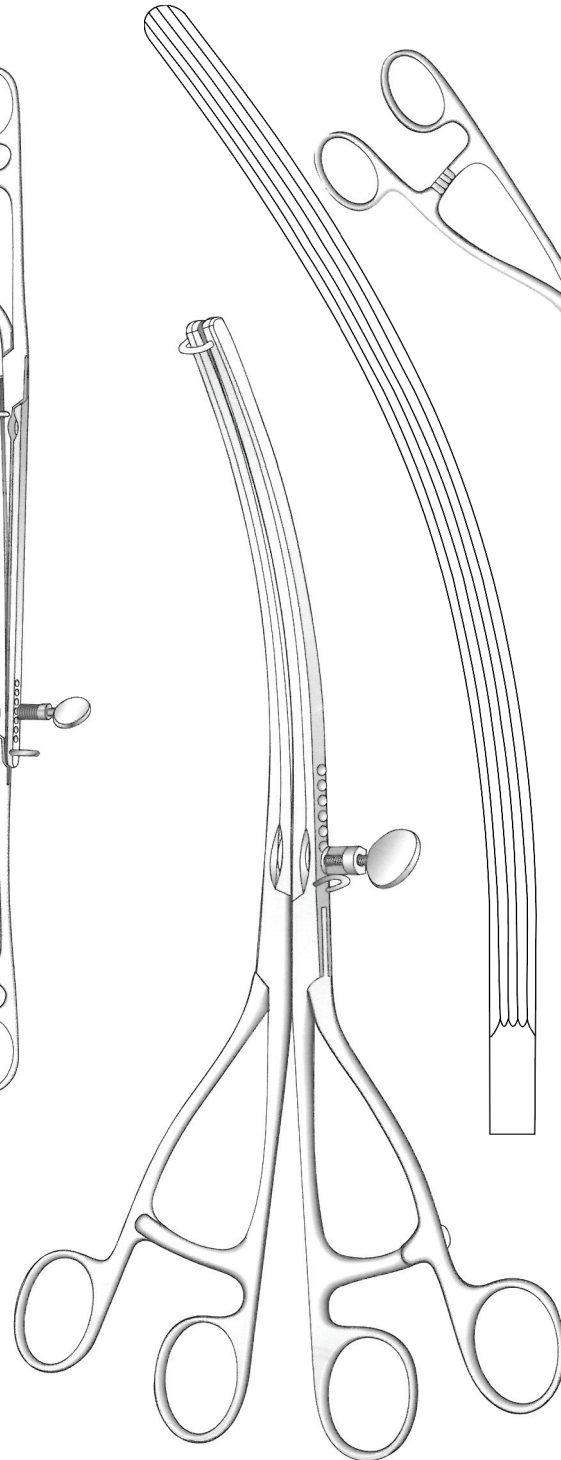

Lane  
V-035-640  
30 cm / 12"

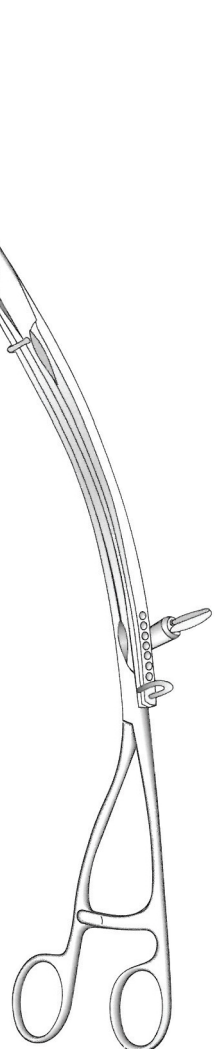

V-035-641



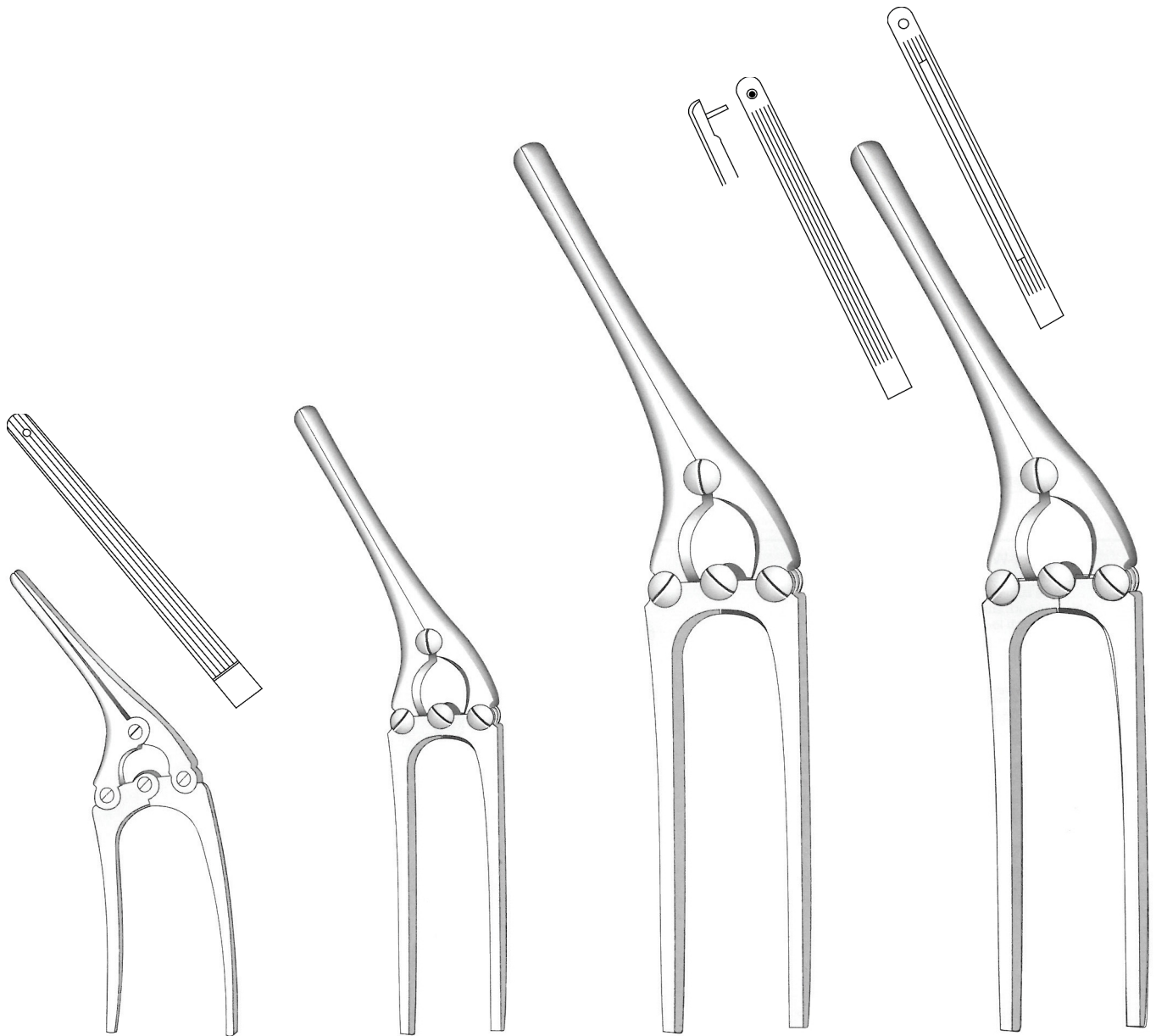

**Payr-Baby**  
**V-035-650**  
 15 cm / 6"  
 With pin

**Payr**  
**V-035-660** With pin  
**V-035-661** Without pin  
 21 cm / 8 1/4"

**Payr**  
**V-035-670** With pin  
**V-035-671** Without pin  
 29 cm / 11 1/2"

**Payr**  
**V-035-680** With pin  
**V-035-681** Without pin  
**V-035-679** With groove  
 35 cm / 14"

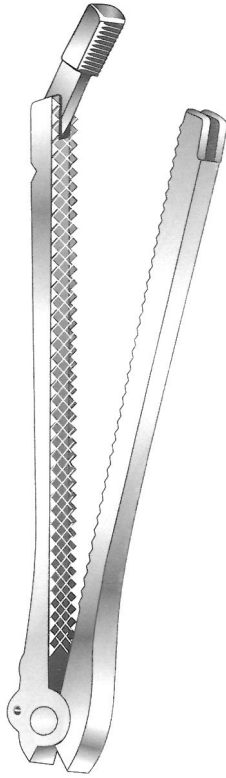

**DeMartel-Wolfson**  
 Anastomosis Clamps  
 Sets consist of  
 2 clamps with short grip  
 1 clamp with long grip

- V-035-682** Set of 3, long clamps
- V-035-683** 5 cm / 2", clamp with short grip
- V-035-684** 5 cm / 2", clamp with long grip
- V-035-685** Set of 3, long clamps
- V-035-686** 7.5 cm / 3", clamp with short grip
- V-035-687** 7.5 cm / 3", clamp with long grip
- V-035-688** Set of 3, long clamps
- V-035-689** 10 cm / 4", clamp with short grip
- V-035-691** 10 cm / 4", clamp with long grip

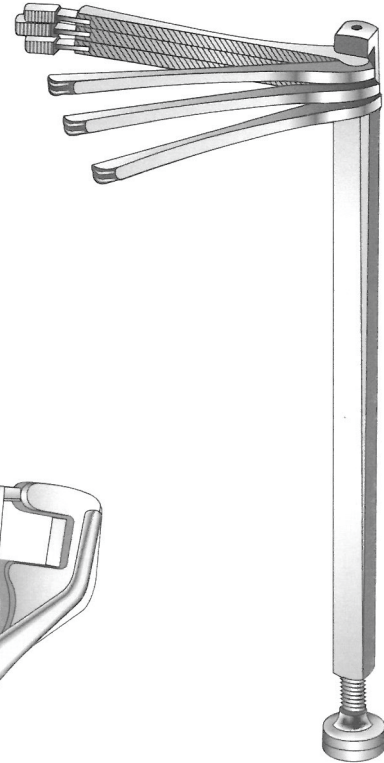

**V-035-692** 8.5 cm / 3¼"  
**V-035-693** 23 cm / 9"  
 Clamp holder

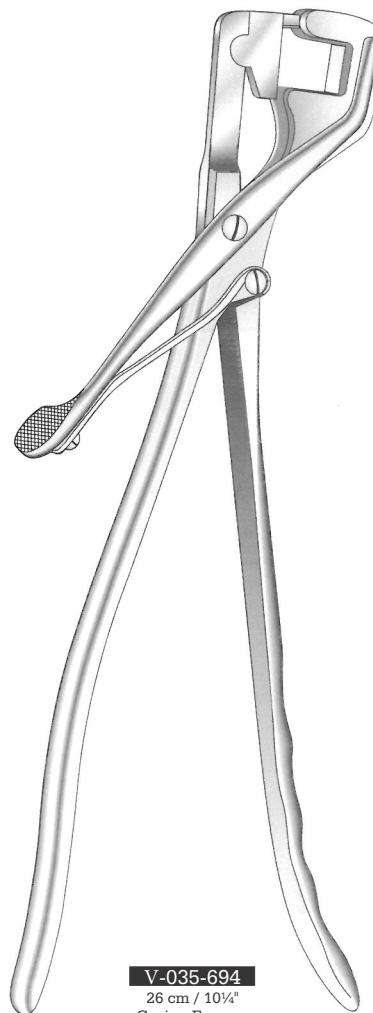

**V-035-694**  
 26 cm / 10¼"  
 Cosing Forceps



Serving Healthcare Since 1971

## CONTACT US

Creative Industries Centre,  
Glaisher Drive Wolverhampton Science Park,  
Wolverhampton United Kingdom,  
WV10 9TG

**Email queries:**

[info@volmed.co.uk](mailto:info@volmed.co.uk) / [sales@volmed.co.uk](mailto:sales@volmed.co.uk)

[www.volmed.co.uk](http://www.volmed.co.uk)